

Paperless Recorder



Type: PHF



PAPERLESS RECORDER PAPERLESS RECORDER
PAPERLESS RECORDER



Long Term Record Data Saving

4years in Compact Flash
(In case of using 512MB Compact Flash)



Saved Data playback

Saved data in Memory card can be easily called out and played back on display



Communication

Ethernet (10Base-T) is available. (option)



Screen saver

Period of non-operation exceeds the setting value of parameter, recorder turns off the backlight of LCD.



PC support softwares (Data Viewer/Parameter Loader)

Supplied in a CD-ROM as a part of standard accessory



Compact size

160 (W) X 144 (H) X 185 (D) mm (Panel mount)1.5 kg compact size



3-point recording and 6-point max. recording

12 types of thermocouples, 5 types of resistance bulbs and voltage/current input are available

PAPERLESS RECORDER

Memory Card Data Saving

Provides flexibility and variety in the handling of record data.



Status Display

Allows you to display screen name, calendar, alarm information, recording status, writing status of measured data in Compact Flash, and fitting status of the card into the recorder slot.

Time display

Indicates the time and time scale of recorded data.

Trend Display

Allows you to view measured result in waveforms.

Digital Display

Allows you to view measured values in a digital form.

Key panel

Allows you to perform the recording start/stop, selection of display, setting, data display/change.

Power indicator

During power on, LED turns on. While screen saver is working, it flickers.

About 4 years' worth of data can be recorded in Compact Flash (512 MB).



Communication

- Ethernet (10Base-T) is available. It has FTP, HTTP (Web server), SMTP and MODBUS-TCP protocols.

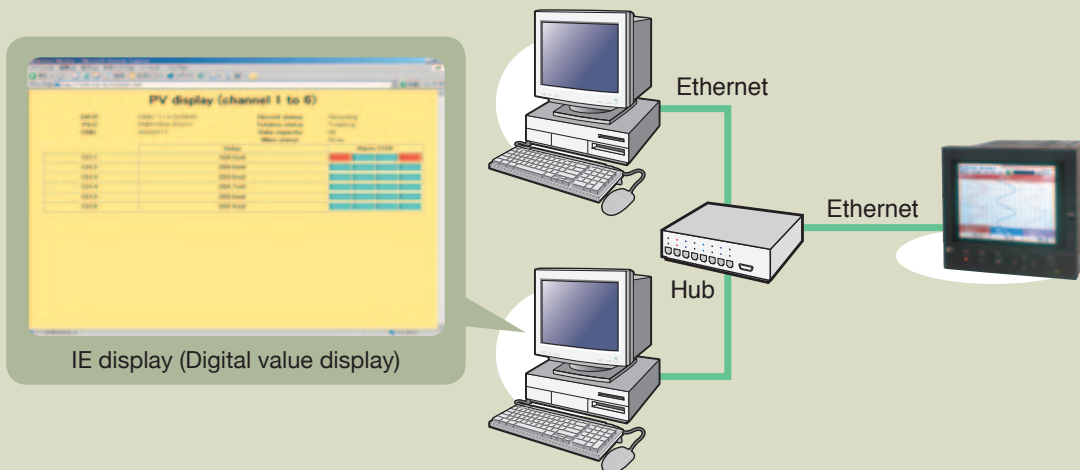

Calculation function offered as standard

Subtraction

Difference between the values of each channel can be calculated.

Square root extraction

Square root extraction of the input value of each channel can be performed.

Wide variety of display mode

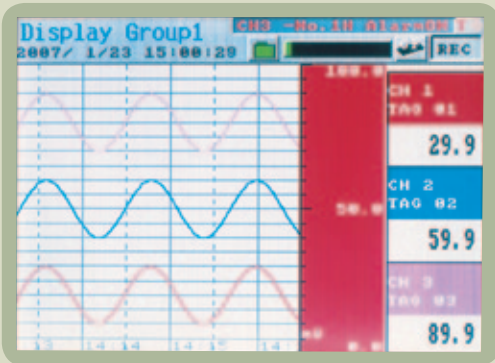

Trend recording (horizontal)

Measured result is horizontally displayed in real time.

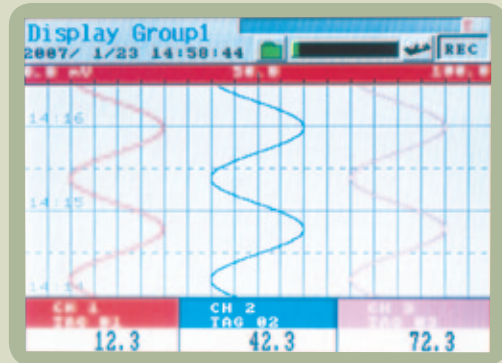

Trend recording (vertical)

Measured result is vertically displayed in real time.

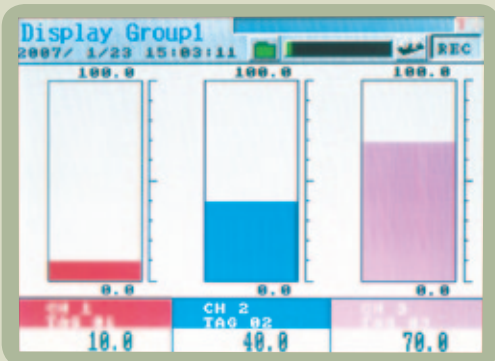

Bar graph

Measured values are displayed in bar graph.

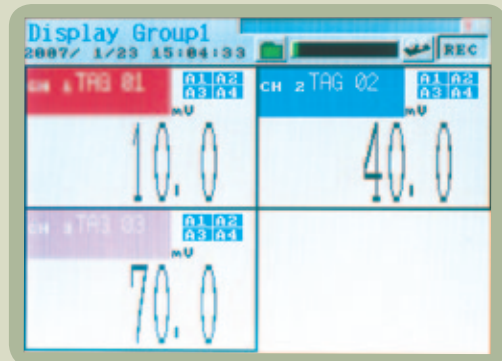

Digital display

Channel No., Tag No. engineering unit, and alarm information are displayed in digital form, in addition to measured values.

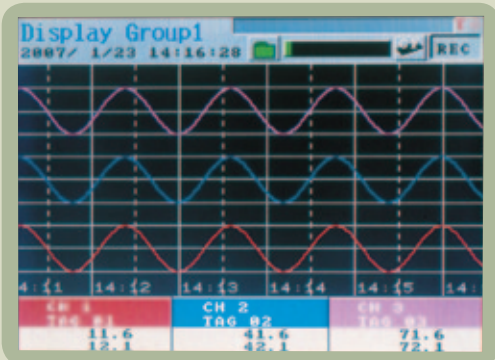

Historical trend display

Past data saved to Compact Flash can be viewed. Scroll function is usable.

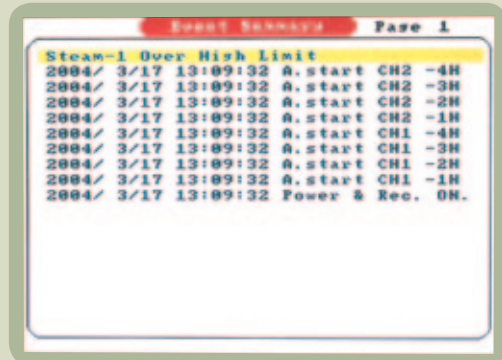

Event summary display

Alarm status and external control input status for each channel are displayed.

Easy operation without the help of the instruction manual

The onscreen guidance enables you to set/change various parameter data easily.



Setting Menu screen

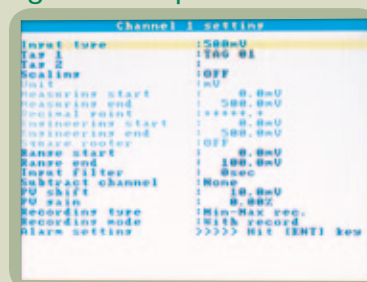

Setting screen

Ethernet

Feature

Ethernet communication connects PHF recorder to industrial network and/or Internet. (Option)

Web

FTP

E-mail

MODBUS-TCP

and more features such as

- ▶ Easy setup, with no need for communication converters
- ▶ Standard Loader software enables reading/writing of the PHF's parameter settings

▶ Web function

You can display process values and/or event summary using Internet Explorer. (Netscape is not supported)

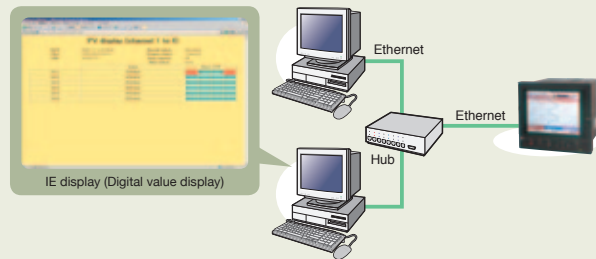

▶ FTP function

The record files in Compact Flash can be listed, downloaded to PC and deleted from Internet Explorer. Recorder configuration can also be uploaded/downloaded.

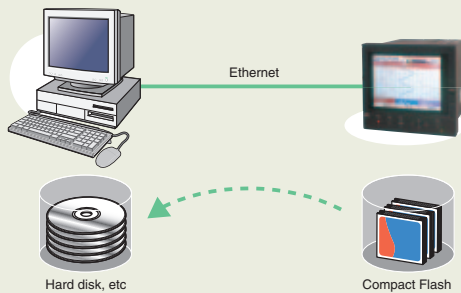

▶ E-mail function

PHF recorder can send E-mails to maximum 8 addresses at up to 10 trigger timings through a mail server on the same LAN.

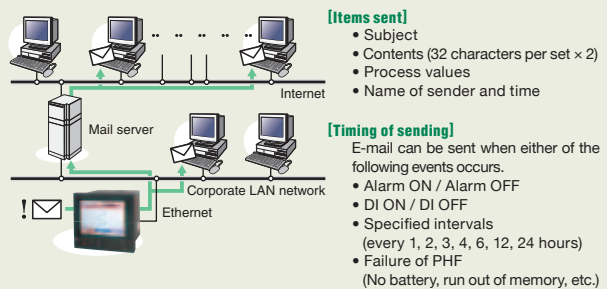

▶ MODBUS-TCP function

You can link the recorder with all network, supervisor or SCADA system by MODBUS TCP/IP protocol.

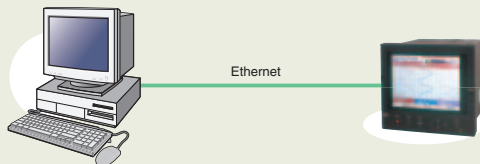

▶ Easy connection

Ethernet communication need no communication software.

	Ethernet	RS485
Wiring		
Software	<ul style="list-style-type: none"> • No communication software. Internet Explorer and Fuji standard software (Parameter loader and Data Viewer) are all you need. 	<ul style="list-style-type: none"> • Dedicated communication software is necessary to be created.

Ethernet specification :

Internet Explorer can be used as a browser (Netscape is not supported). Windows 2000 or XP is required.

◆Http (server)

You can browse the following screens by setting PHF's IP address on Internet Explorer (ver.6). (Change of setting value is not possible)

[Measured value display screen]

- PV value for each channel (instantaneous value)
- Recording condition
- Memory usage of Compact Flash
- Alarm Status

[Event summary screen]

- The information on the event summary screen of the recorder.

◆FTP (server: read only)

FTP server function allows you the followings by setting PHF's IP address on Internet Explorer.

- Browse of file names in the Compact Flash
- Files can be downloaded to PCs, deleted or changed their names.

It's also available to access by using command prompt. User ID and password are needed to access to recorder. (simultaneous access by multiple users is inhibited)

◆SMTP (client)

E-mail can be sent when the mail server is available in the same LAN network. E-mail cannot be received from an external network. The items sent and timing of sending are as follows.

[Timing of sending]

- DI ON, DI OFF
- Alarm ON, Alarm OFF
- Failure occurred in main unit (no battery, memory card is full, etc.)
- Periodic

[Items sent]

- Subject of E-mail (32 characters)
- Message (32 characters x 2)
- PV value (instantaneous value)
- Sent time
- Name of sender

[Number of registered recipient addresses]

- 8 (the items and timing can be set for each recipient)

◆MODBUS-TCP

Communication with MODBUS-TCP protocol through Ethernet is available. Reading from each parameter, and writing/reading is enabled (for details, refer to the separate communication manual).

◆Loader software

Loader software installed as standard enables parameter settings to be read and written, but writing is not allowed during recording.

◆Communication medium

Ethernet (10BASE-T)

Specifications

General specifications

Mounting method	Panel flush mounted
Material	Molding resin (case, bezel)
External dimensions and mass	<Panel mount> 160 x 144 x 185 mm, about 1.5 kg (6-point input)
Power supply voltage	100V to 240V AC, 50/60 Hz
Power consumption	About 42VA (at 240VAC)
External terminals	Screw terminals (M3 thread)
Operate temperature	0 to 50°C (in case the 12th digits of code symbols is "Y".) 0 to 40°C (in case the 12th digits of code symbol is "E".) Note: In case of 30 degree C or more for ambient temperature, This display might be fogged little bit. (This is not out of order.)

Input unit

No. of inputs	3 or 6 points
Measuring cycles	100ms
Recording cycle	1sec to 12hours
Input signal	Thermocouple: 12 types (B, R, S, K, E, J, T, N, W, L, U, PN) Resistance bulb: 5 types (Pt100, JPt100, Ni100, Pt50, Cu50) DC voltage: (0 to 50mV, 0 to 500mV, 0 to 5V or 1 to 5V) DC current: (connecting optional shunt resistor to input terminal)
Input types	Selected from the key panel (the same type should be set for every 2 channels)
Burn-out function	Equipped with thermocouple and resistance bulb inputs as standard.
Calculation function	Primary delay filter, scaling, calculation of difference between channels, and square root extraction

Display unit

Display	5.7" STN color LCD (320 X 240 dots) (The LCD may have some pixels that do not stay on or off. Due to the characteristics of liquid crystal, the brightness may not be uniform, which is not a failure.)
Life of backlight	50,000 hours
Display contents	•Trend display (in vertical and horizontal direction) selected in the refreshment cycles of 1 sec to 12 hours. Scale display/non-display selectable •Bar graph display (refresh cycle: 1 second) •Digital display (in refreshment cycle of 1 sec) •Event summary display (alarm and message summary) •Historical trend display (Compact Flash memory data.)

Recording function

Recording medium	Compact Flash card (Format as FAT16 or FAT, or recorder can't read and write.)
Memory capacity	2GB, max.
Recording method	Writing starts in fixed cycles by turning ON the REC key on the front panel. Data is recorded in a new file every time the recording starts.
Data save cycles	Links to refreshment cycle of the trend display
Data format	•ASCII About 118 bytes per sampling (at 6 channel inputs) •Binary (Data cannot be read directly into Excel, etc.) About 28 bytes per 1 sampling (6-channel input)
Trend data	Maximum value and minimum value are saved from the data that are sampled in measuring cycles.
Event data	Alarm data and message data are saved.
Storage capacity	•About 4 years at display refresh cycle of 30 seconds (ASCII) •About 16 years (Binary) (6-channel recording, 512MB compact flash used)

Amount of memory used	The display unit displays how much the memory card has been used via bar graphs. The recording will stop if the amount of recorded data exceeds the capacity.
-----------------------	---

Alarm function

No. of settings	Up to 4 alarms are settable for each channel.
Type of alarm	High/Low limits
Indication	Alarm status is displayed on digital display unit when an alarm occurs. Histories are displayed in the alarm summary.
Output	10 points as relay output (option)

Reference performance

Indication accuracy	±(0.15%+1 digit) of input range Accuracy of the next range is ±(0.3%+1 digit). Thermocouple B: 400°C to 600°C, thermocouples R and S: 0°C to 300°C, thermocouples K, E, J, T, L, and U: -200°C to -100°C
Indication resolution	0.1°C
Reference junction	±0.5°C
Compensation accuracy	Thermocouples R, S, B and W: ±1.0°C
Input resistance	About 1MΩ

Others

Clock	With calendar function
Memory backup	Parameter settings are saved to the internal non-volatile memory. The clock is backed up by a built-in lithium battery. Trend data is back up only 400 samplings.
Memory full alarm	When the amount of recorded data exceeds the capacity of memory card, recorder can energize the alarm output.
Low battery alarm	When the battery for backup of clock and SRAM becomes low, recorder can energize the alarm output.

Optional specification

Alarm (relay) output/DI	10 relay outputs and 5 DI are added. Alarm output: SPST Output for each channel or common channel is possible. DI input: 5 no-voltage contact input points, Recording start/stop, or LCD turning on functions can be performed.
-------------------------	---

Communication

Communication (Ethernet)	10Base-T FTP server * (Internet Explorer 6. FFFTP or Comand Prompt are available) HTTP server * (Web server. Internet Explorer 6 is available) SMTP (e-mail client) MODBUS-TCP * Netscape and Mozilla Firefox are not available
--------------------------	--

PC support software (standard-supplied CD-ROM)

O/S PC/AT-compatible machine	Windows XP/2000 Operation on PC98-series machines by NEC is not guaranteed. Operation on self-made or shop-brand PCs is not guaranteed.
Required memory capacity	64 MB or more
Contents	The following types are included as standard. 1) Data viewer software It allows you to view the past trend recorded data from the data saved to the Compact Flash on PC. Historical trend and event display functions are provided. 2) Parameter loader software It allows you to perform setting/change of various parameters on PC.

A convenient PC support software package is included as standard

Past data saved to Compact Flash can be viewed on personal computer.

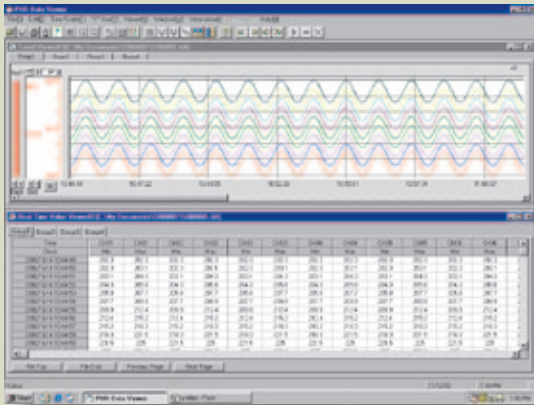

Historical trend data screen

Parameters for the recorder can be easily set and changed from personal computer.

Parameter setting screen



- Before use, install PC support software supplied as standard.
- O/S: Windows XP/2000
 - Required storage capacity: 64 MB
 - Provide PC card adapter separately.
Recommended type: PHZP051
PC/AT-compatible machine
 - Operation on PC98-series machines by NEC is not guaranteed.
 - Operation on self-made or shop-brand PCs is not guaranteed.



- Before use, install PC support software supplied as standard.
- O/S: Windows XP/2000
 - Required capacity of memory: 64 MB
 - A communication cable between recorder and pc is optional.
Type: PHZP1801
PC/AT-compatible machine
 - Operation on PC98-series machines by NEC is not guaranteed.
 - Operation on self-made or shop-brand PCs is not guaranteed.

Outline Diagram and Panel Cut (Unit: mm)

Panel mount type

3 or 6-points input

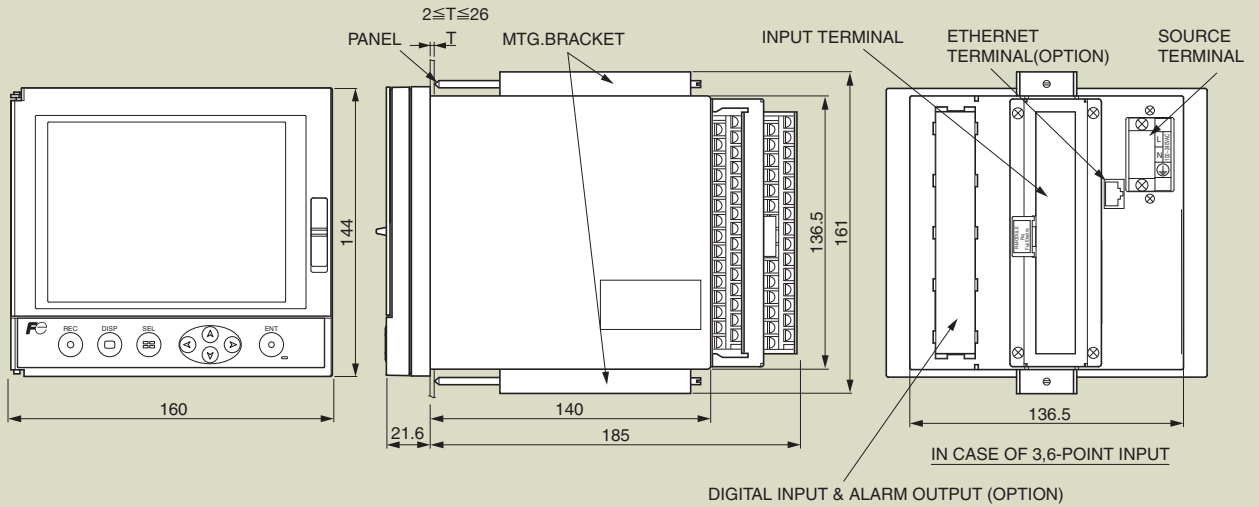

Note: When placing the main unit on another instrument or on the floor, allow a space of 100mm or more between the unit and instrument or the floor.

Panel cutout

For mounting one unit

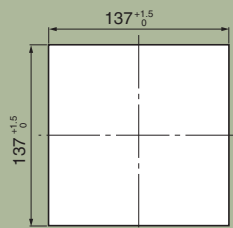

For mounting multiple unit

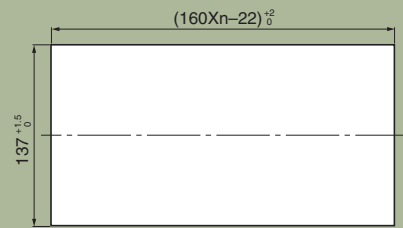

External connection diagram

3 or 6-points input

ALARM OUTPUT / DIGITAL INPUT TERMINAL

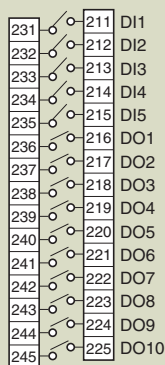

INPUT TERMINAL

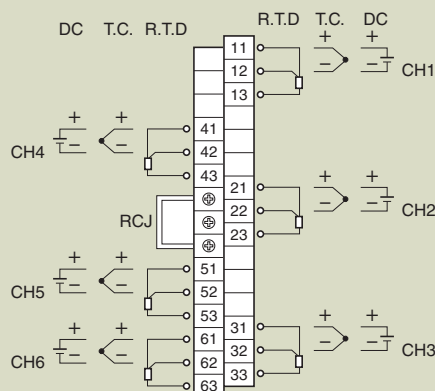

SOURCE TERMINAL

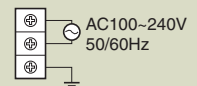

Note 1: For current input, connect an optional shunt resistance to a voltage input terminal.
 Note 2: Please do not use any input terminal which is not needed.

Code Symbols

Digit	Specifications	Note
4	<Number of input points> 3 6	
11	<Alarm (relay) output/DI input> Without With	
12	<Communication> Without With Ethernet	

PHF 4 5 6 7 8 - 9 10 11 12 13
 1 B 1 1 - E 1 V

Note 1: Input signals are classified into the following 4 groups. Make the setting so that channel 4 and 5 are assigned the input signal categorized in the same group.
 Group 1: Thermocouple (12 kinds), 50mV
 Group 2: Pt100, JPt100, Ni100, Cu50, Pt50
 Group 3: 500mV
 Group 4: 1-5V, 0-5V

Scope of supply

Item	Quantity
Main unit	1
Panel mounting bracket	1
CD-ROM (PC software and Instruction manual)	1
Noise filter for power cable	1

Option

Item	Type	Specifications
Shunt resistor for DC current input	PHZP0101	10Ω±0.1%
PC loader communication cable	PHZP1801	With USB A and USB miniB Connector (3m)
CD-ROM	PHZP2101	Instruction manuals and softwares
PC card adapter for Compact flash	SDAD-38	Maker : Sandisk
Compact flash (512MB)	PHZP1301-512	
Compact flash (1GB)	PHZP1301-01G	

Note 1: Windows, Excel and Internet Explorer are registered trademarks of Microsoft Corporation.
 Note 2: SanDisk compact flash is a trademark of SanDisk.
 Note 3: PC98 series are registered trademarks of NEC Corp.
 Note 4: MODBUS® is the registered trademark of AEG Schneider Autmation International.
 Note 5: Netscape is the registered trademark of Netscape Communication Corp.
 Note 6: Mozilla Firefox is the registered trademark of Mozilla Foundation.

Fuji Electric Co., Ltd.

International Sales Div.

Sales Group

Gate City Ohsaki, East Tower, 11-2, Osaki 1-chome,
 Shinagawa-ku, Tokyo 141-0032, Japan

<http://www.fujielectric.com>

Phone: 81-3-5435-7280, 7281 Fax: 81-3-5435-7425

<http://www.fujielectric.com/products/instruments/>